

Closed State

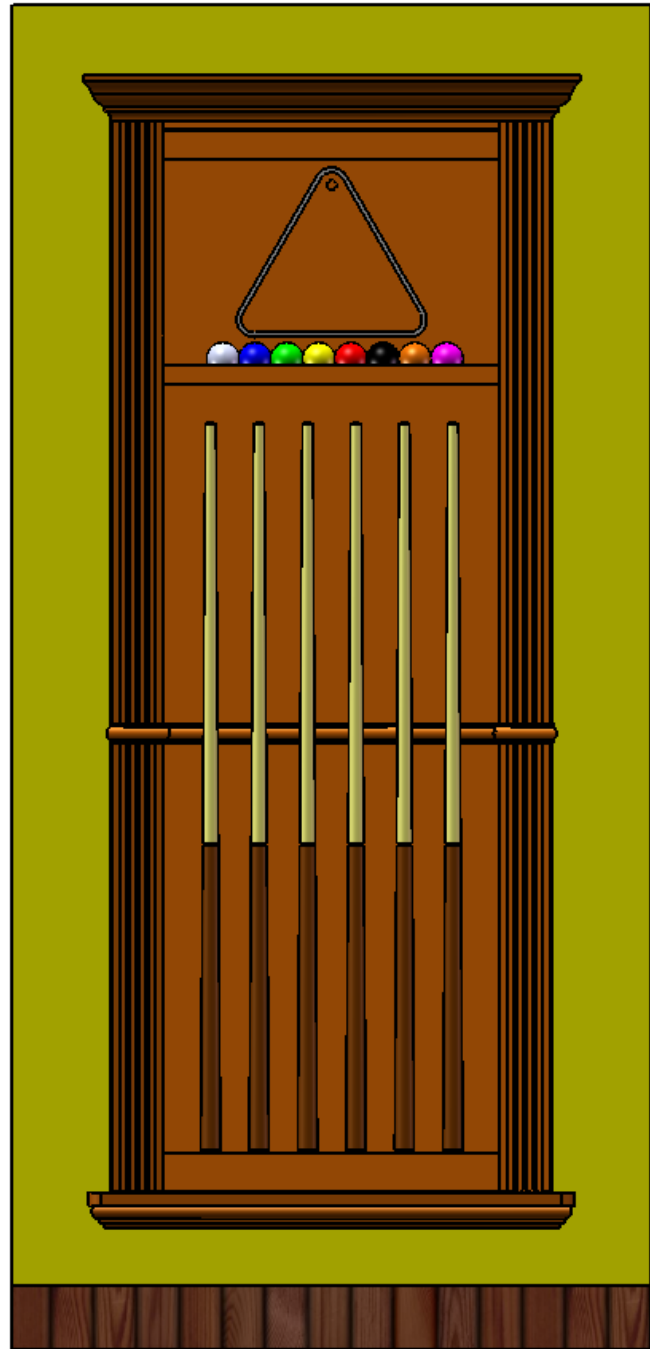

Open State

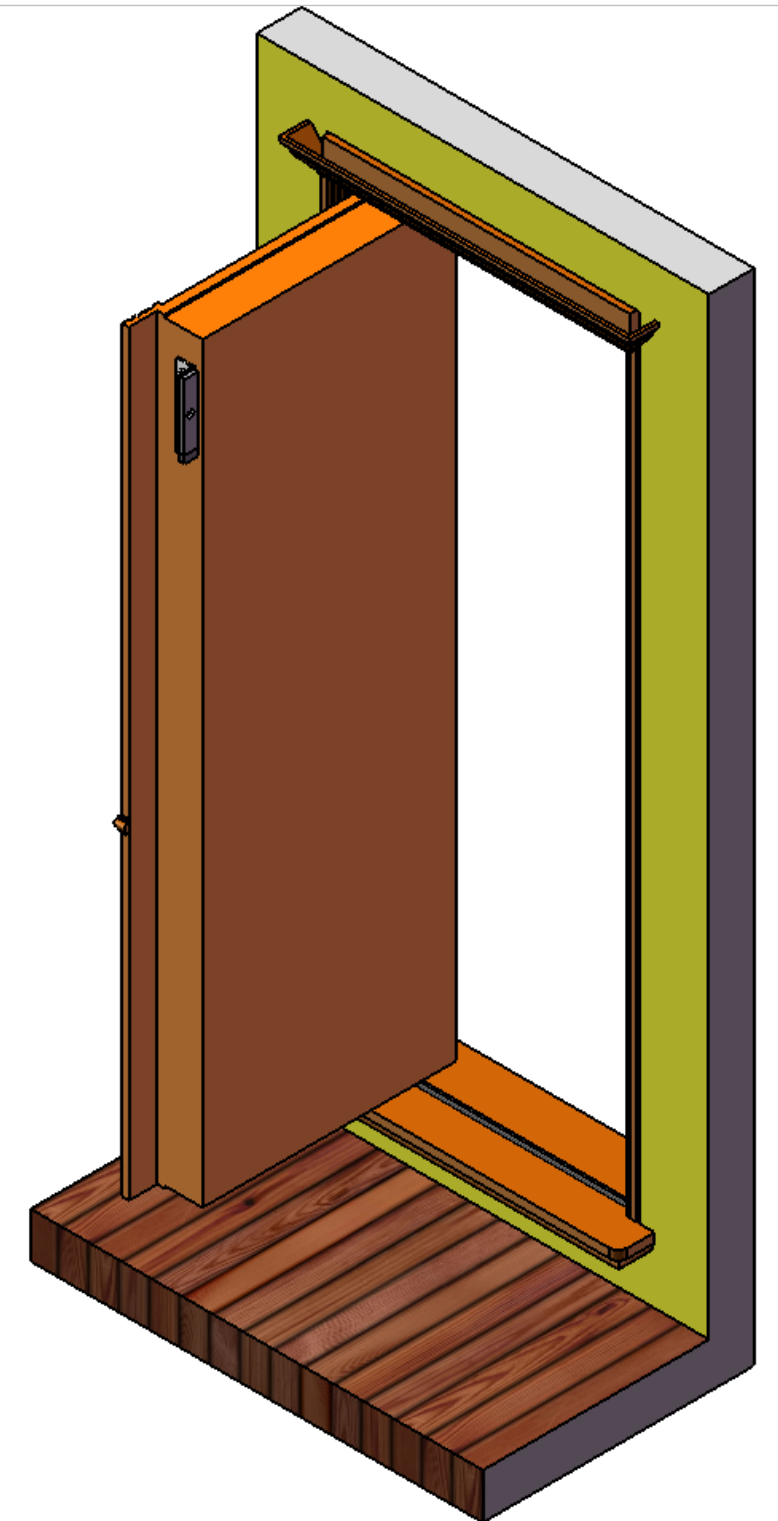
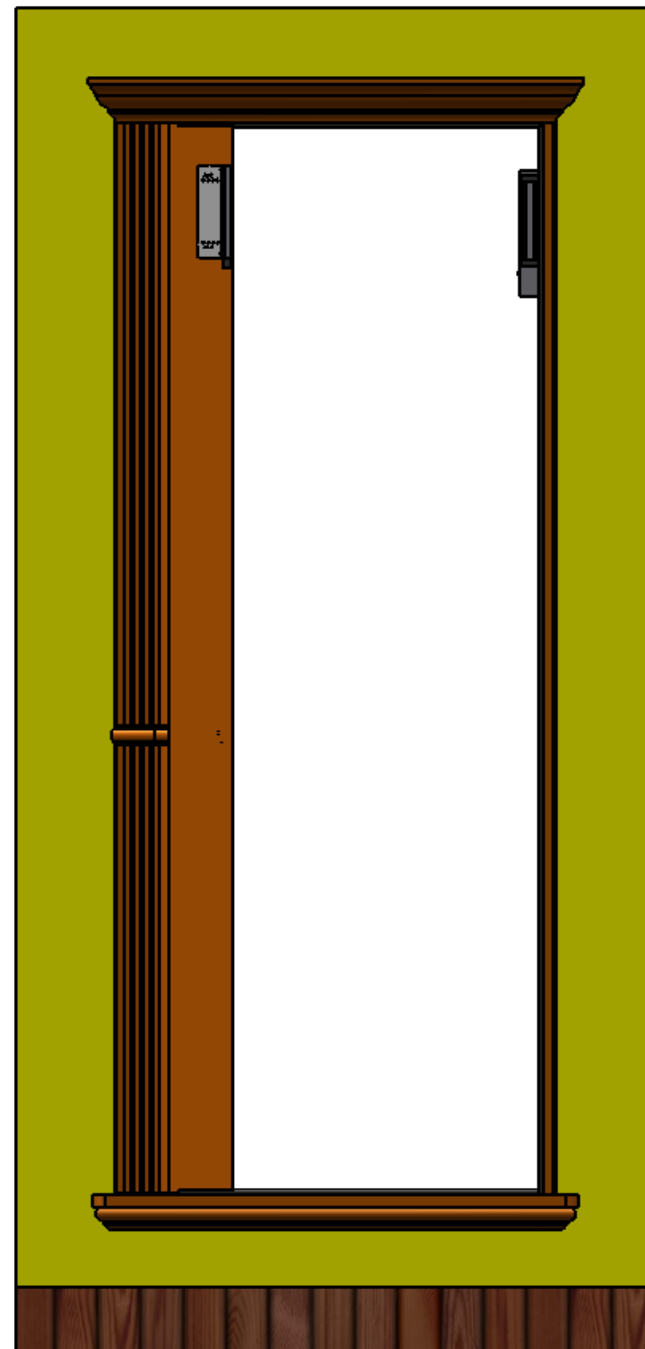

PROPRIETARY AND CONFIDENTIAL
 THE INFORMATION CONTAINED IN THIS
 DRAWING IS THE SOLE PROPERTY OF
 CREATIVE HOME ENGINEERING LLC. ANY
 REPRODUCTION IN PART OR AS A WHOLE
 WITHOUT THE WRITTEN PERMISSION OF
 CREATIVE HOME ENGINEERING LLC IS
 PROHIBITED.

TITLE: Pool Cue Rack Secret Passage		DESIGNER: S. Humble		DATE:	
UNLESS OTHERWISE SPECIFIED: DIMENSIONS ARE IN INCHES TOLERANCES: ± .050 FRACTIONAL ± 1/32 ANGULAR: MACH ± 1° BEND ± 1° TWO PLACE DECIMAL ± .020 THREE PLACE DECIMAL ± .010		Creative Home Engineering			
INTERPRET GEOMETRIC TOLERANCE PER ANSI STANDARDS					
MATERIAL: Birch	FINISH: Paint-grade	SIZE: B	DWG. NO.: -	REV: -	
DO NOT SCALE DRAWING		SCALE: 1:20		PAGE 1 OF 1	

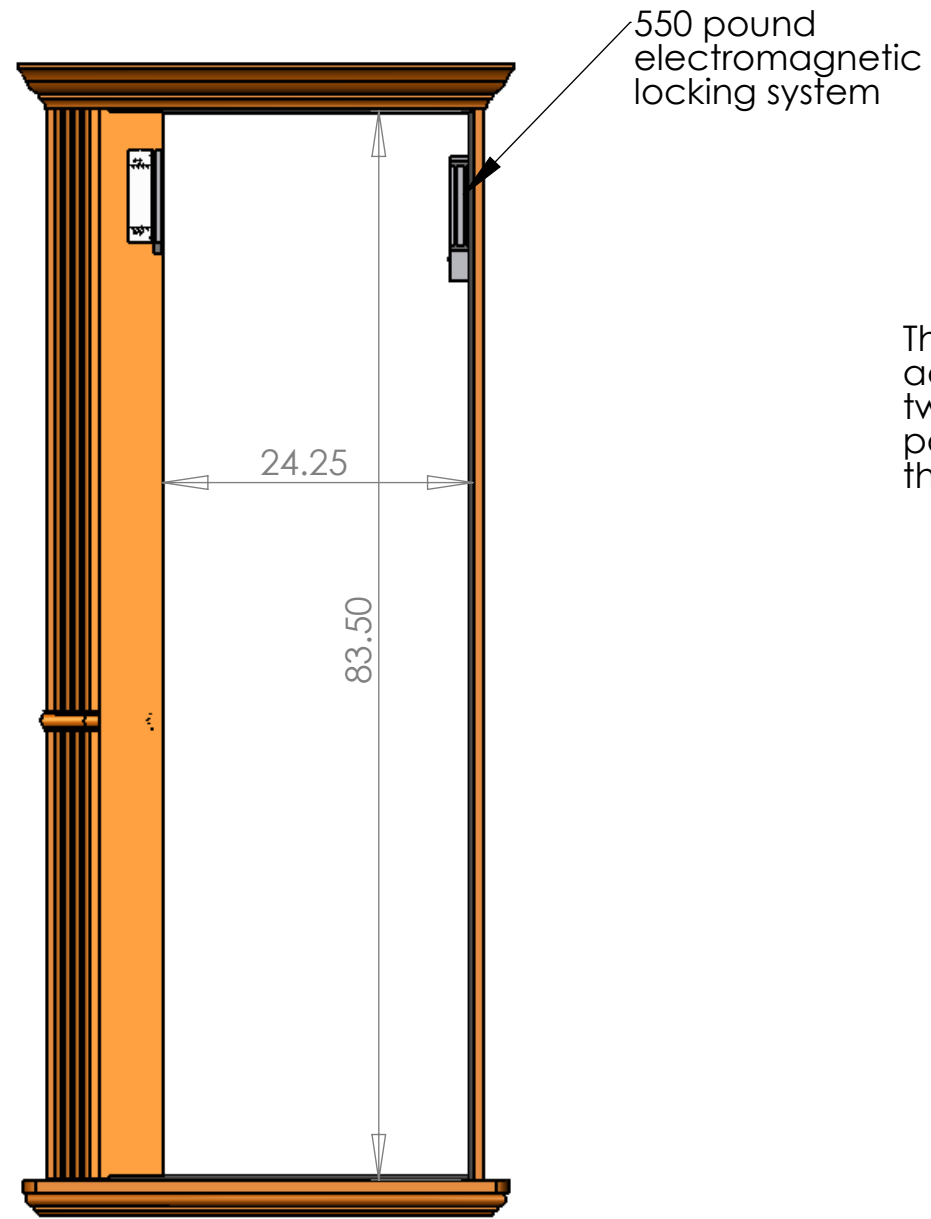

The secret door is activated by twisting whichever pool cue rests in this location.

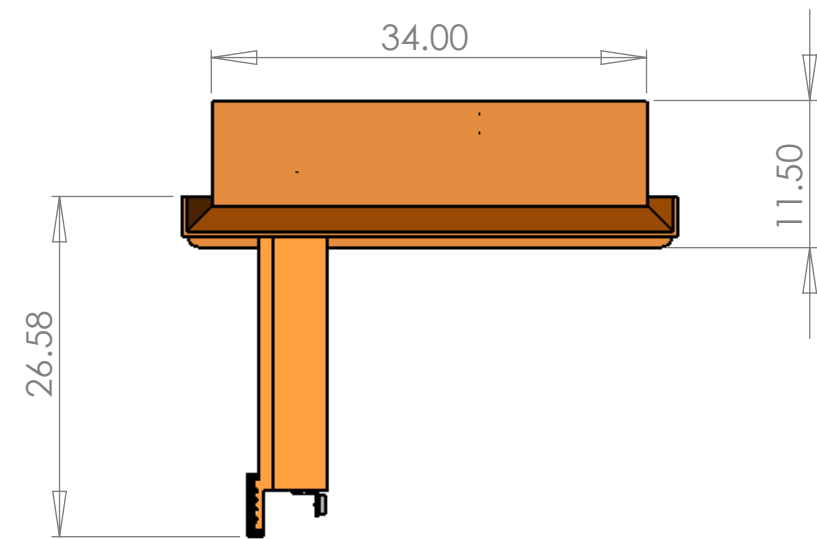
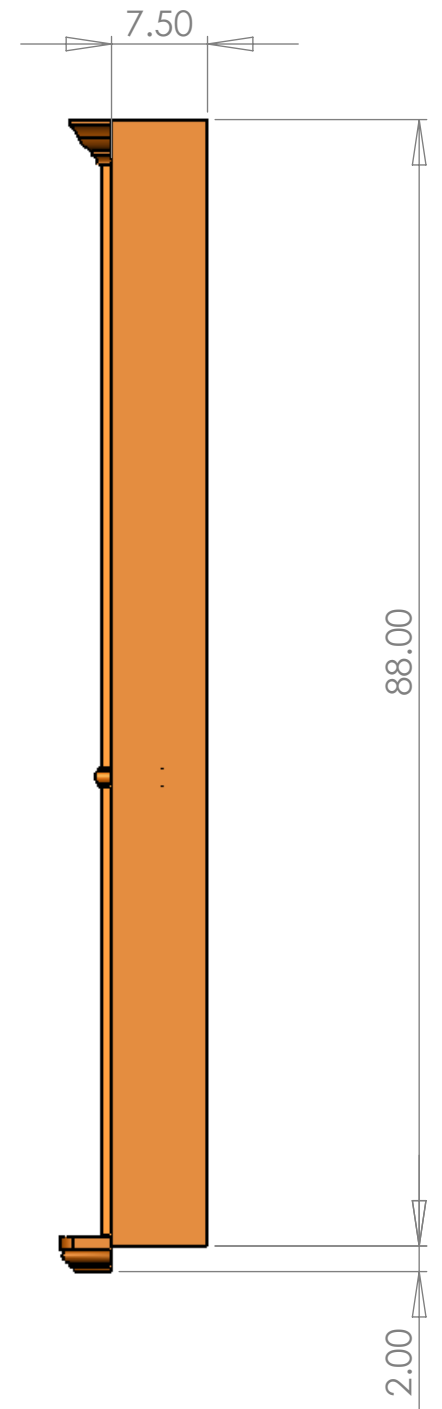
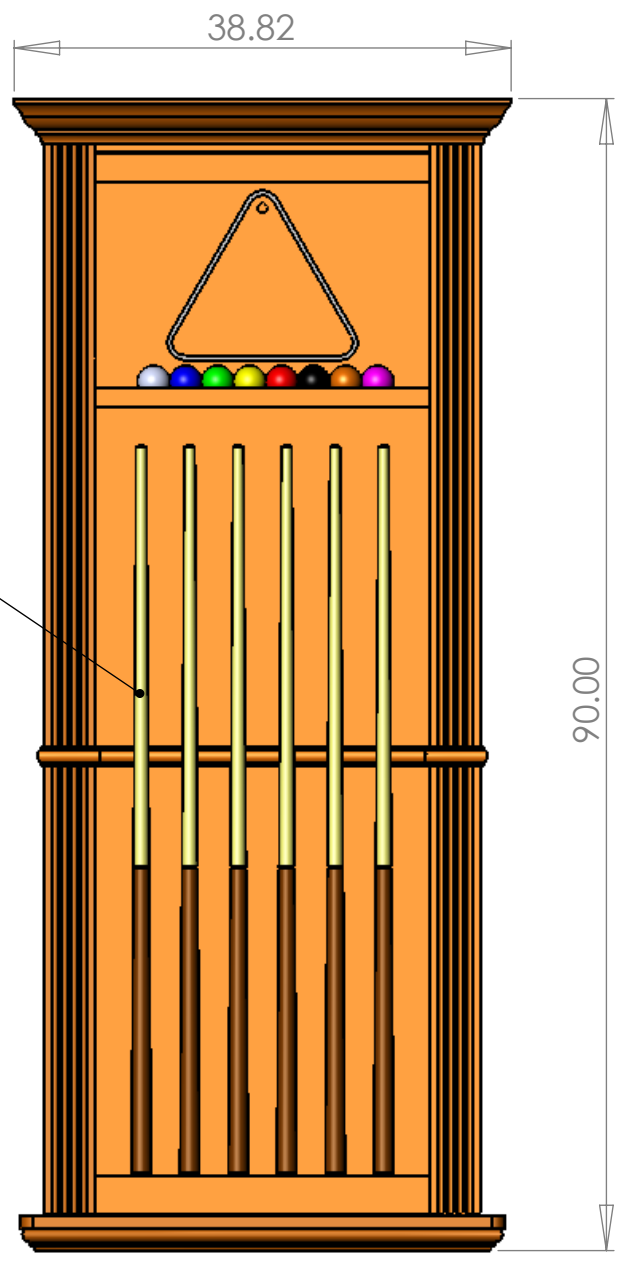

PROPRIETARY AND CONFIDENTIAL
 THE INFORMATION CONTAINED IN THIS DRAWING IS THE SOLE PROPERTY OF CREATIVE HOME ENGINEERING LLC. ANY REPRODUCTION IN PART OR AS A WHOLE WITHOUT THE WRITTEN PERMISSION OF CREATIVE HOME ENGINEERING LLC IS PROHIBITED.

TITLE: Pool Cue Rack Secret Passage			
DESIGNER	S. Humble	DATE	
UNLESS OTHERWISE SPECIFIED: DIMENSIONS ARE IN INCHES TOLERANCES: ± .050 FRACTIONAL ± 1/32 ANGULAR: MACH ± 1° BEND ± 1° TWO PLACE DECIMAL ± .020 THREE PLACE DECIMAL ± .010			
Creative Home Engineering			
MATERIAL	Birch	SIZE	DWG. NO.
FINISH	Paint-grade	B	-
DO NOT SCALE DRAWING		SCALE: 1:50	PAGE 1 OF 1

Required Wall Rough Opening Dimensions

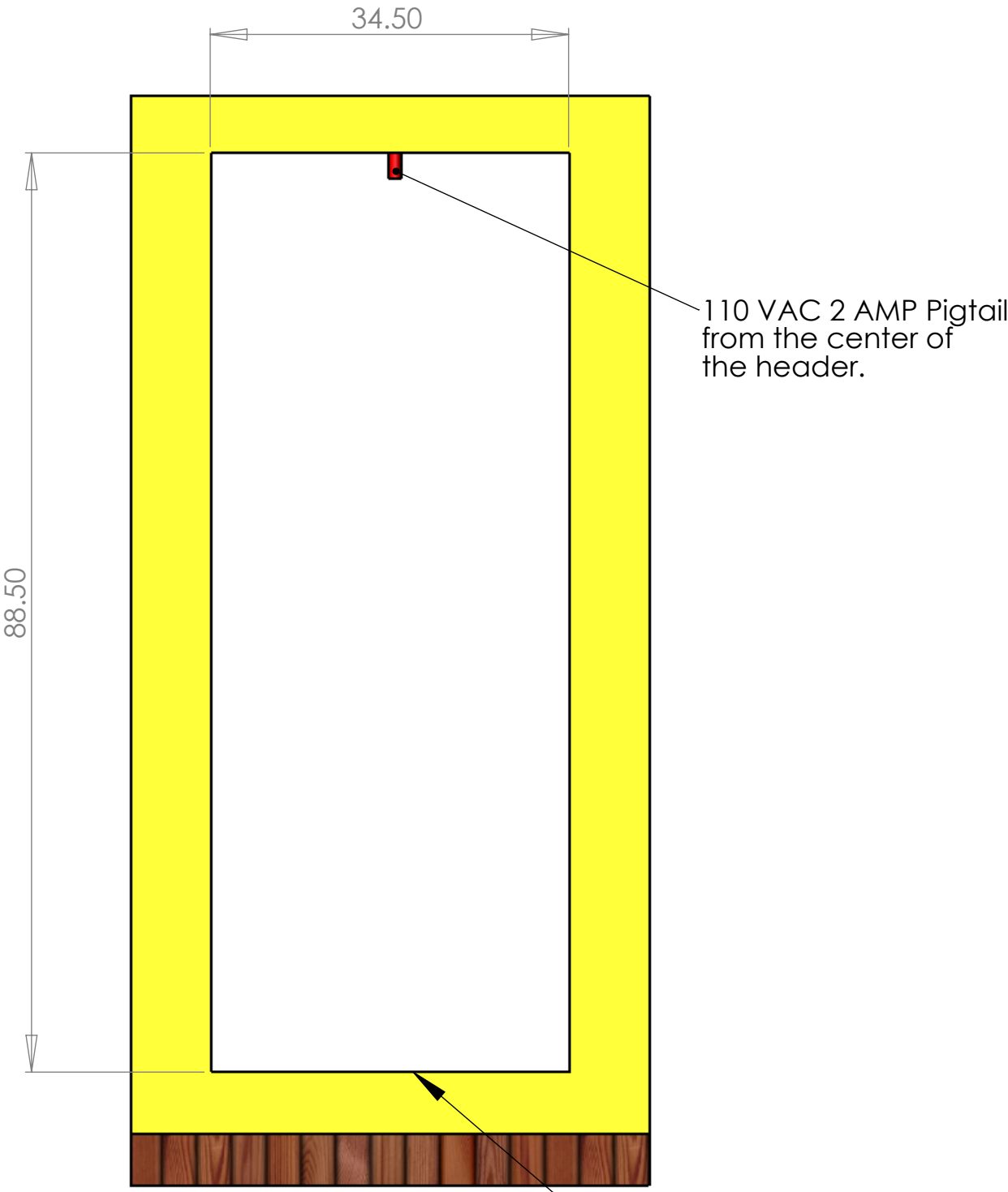

Footer height at least 2" above base boards

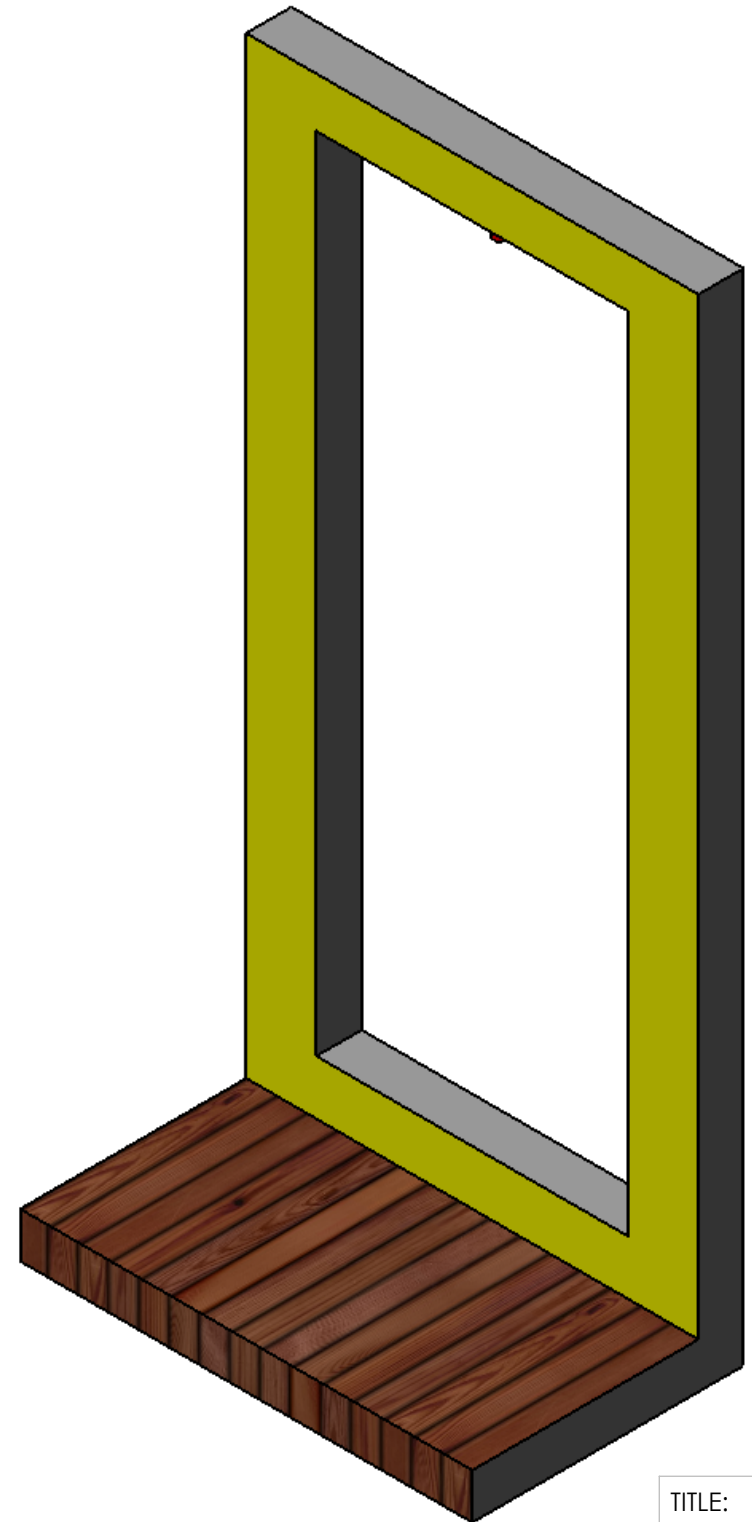

TITLE: Pool Cue Rack Secret Passage		DATE	
DESIGNER S. Humble		Creative Home Engineering	
UNLESS OTHERWISE SPECIFIED: DIMENSIONS ARE IN INCHES TOLERANCES: ± .050 FRACTIONAL ± 1/32 ANGULAR: MACH ± 1° BEND ± 1° TWO PLACE DECIMAL ± .020 THREE PLACE DECIMAL ± .010			
INTERPRET GEOMETRIC TOLERANCE PER ANSI STANDARDS			
MATERIAL Birch			
FINISH Paint-grade	SIZE B	DWG. NO. -	REV -
DO NOT SCALE DRAWING		SCALE: 1:50	PAGE 1 OF 1

PROPRIETARY AND CONFIDENTIAL
 THE INFORMATION CONTAINED IN THIS DRAWING IS THE SOLE PROPERTY OF CREATIVE HOME ENGINEERING LLC. ANY REPRODUCTION IN PART OR AS A WHOLE WITHOUT THE WRITTEN PERMISSION OF CREATIVE HOME ENGINEERING LLC IS PROHIBITED.